



GAZEBO PENGUIN INC.

4660 Hickmore, St-Laurent
Quebec, Canada H4T 1K2

1-800-737-7174 / 514-276-3485

Fax : 1-514-276-4147

customerservice@gazebopenguin.com

**PLEASE READ
IN ITS ENTIRETY
BEFORE
INSTALLATION**

**PLEASE READ
IN ITS ENTIRETY
BEFORE
INSTALLATION**

41215

12 X 15 SOLARIUM

ASSEMBLY INSTRUCTIONS

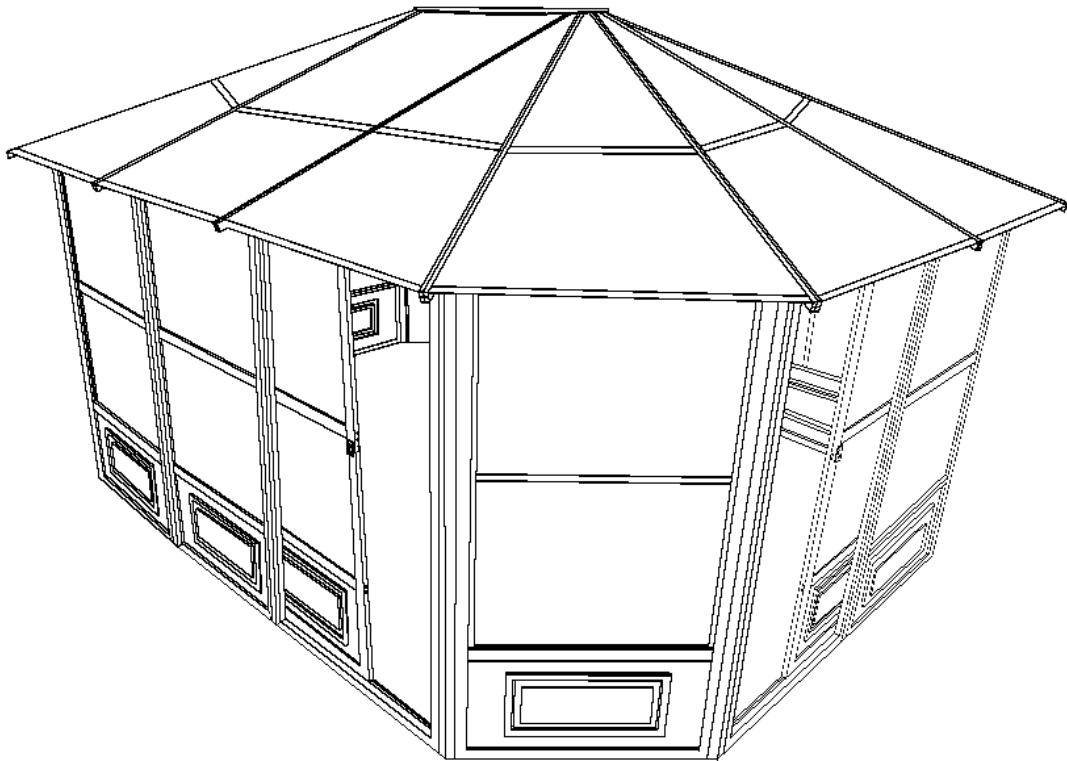

**DO NOT DESTROY THE BOXES UNTIL COMPLETELY ASSEMBLED
PLEASE VERIFY THE CONTENT OF EACH BOX AGAINST THE LIST OF PARTS**

Assembly by three people is recommended.

Base Dimensions 12' ½"x15'6", Largest Dimensions 13'6"x16'11" (see pg.13)

Before you assemble the Solarium

- Please don't destroy boxes until completely assembled.
- Please verify the content of each box against the list of parts.
- It is important that this solarium be installed on a solid base with the provided screws. Otherwise, please ensure that you use anchors sufficient for your surface.
- The solarium should not be installed adjacent to trees or a sloped roof. Snow and ice may slide onto the solarium and cause it to collapse.

Tools needed:

- Step ladder
- #2 Phillips screwdriver
- Rubber mallet

Based on the location, decide where you would like to position the two (2) doors panels which can slide open to the left or the right, your choice.

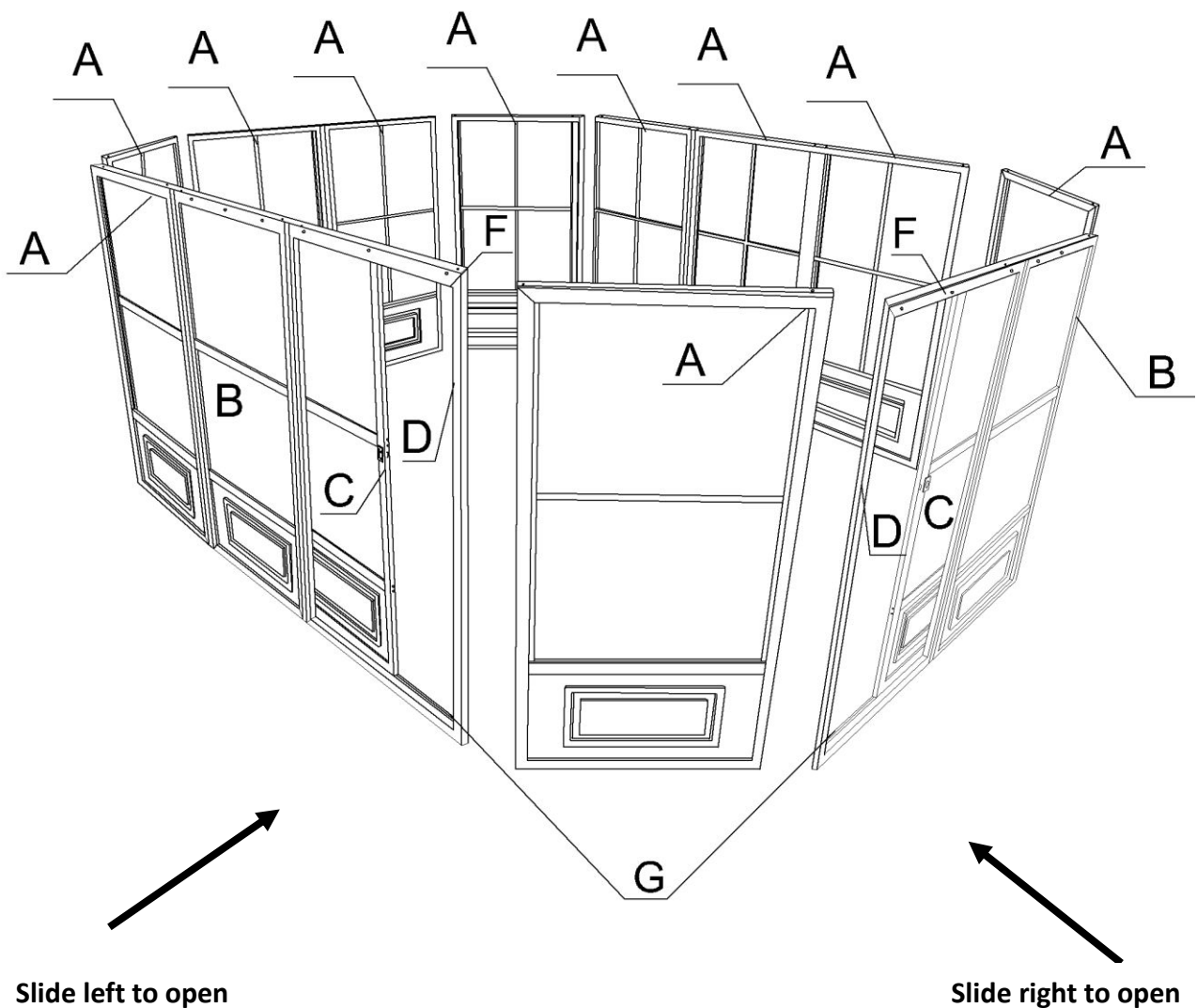

12x15 Solarium Assembly Instructions

Step 1:

Before starting to assemble, please decide where you would like to position the door panels.

1. Stand up two regular frames (A), using two connecting pieces (E) and affix the panels (A) together.
2. Stand up a frame meant to be next to the door (B) and a door frame (D), placing the door frame either on the left or right, then use two connecting pieces (E) to affix the panel and door frame.
3. When assembling angled panels (A, D), you should put the two panels at 135 degree angle then use the angled connecting pieces (I) and (J) to affix the panels together.

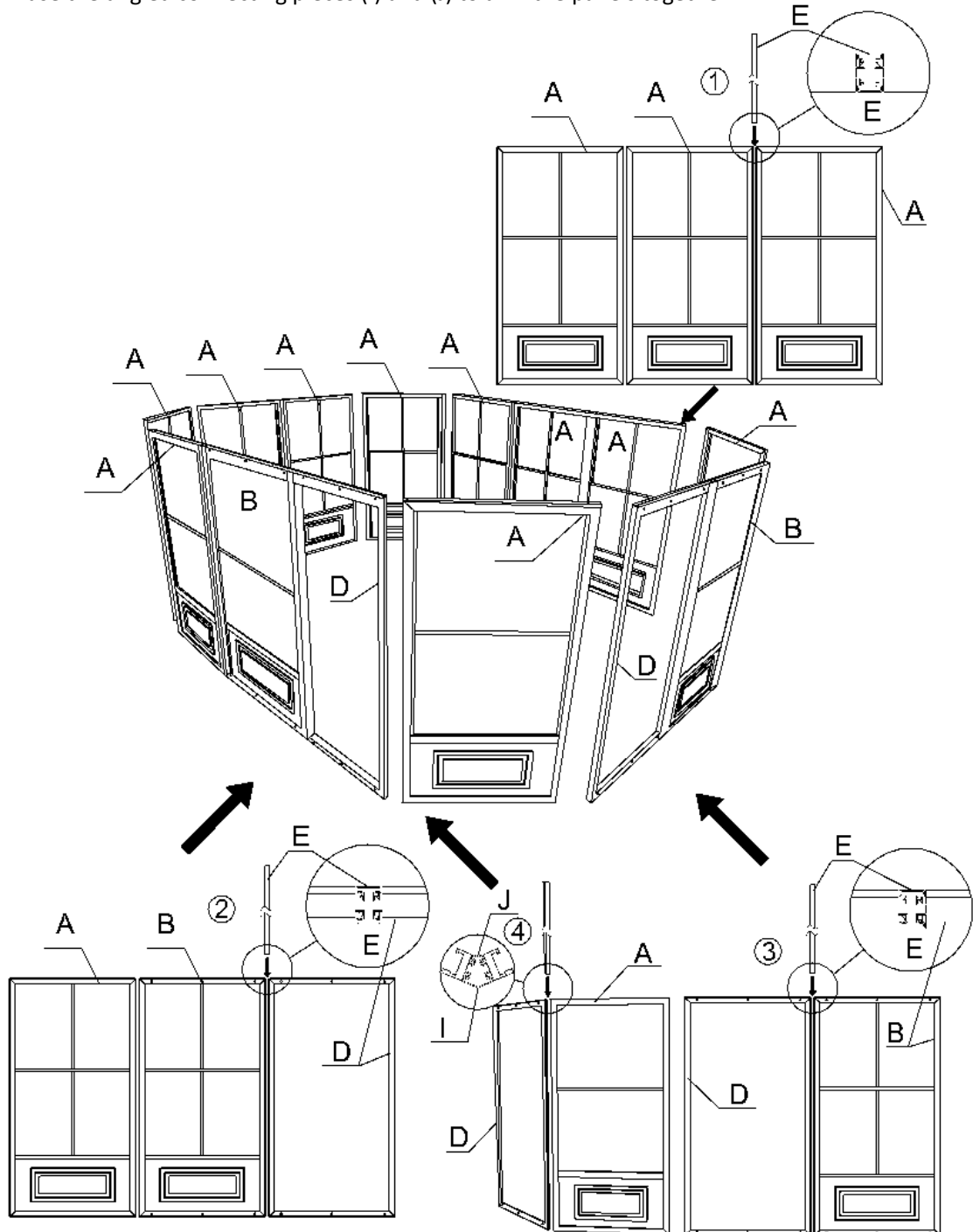

Step 2:

1. Slide top door rail (F) into wheels of sliding door.
2. Slide lower door rail (G) into the plastic guide of the sliding door (C).
3. Use bolt (Bb) to affix the plastic stoppers (H) one on each end of top door rail (F).
4. Use screw (Oo) to affix upper door rail end caps (Nn) one on each end of top door rail (F).

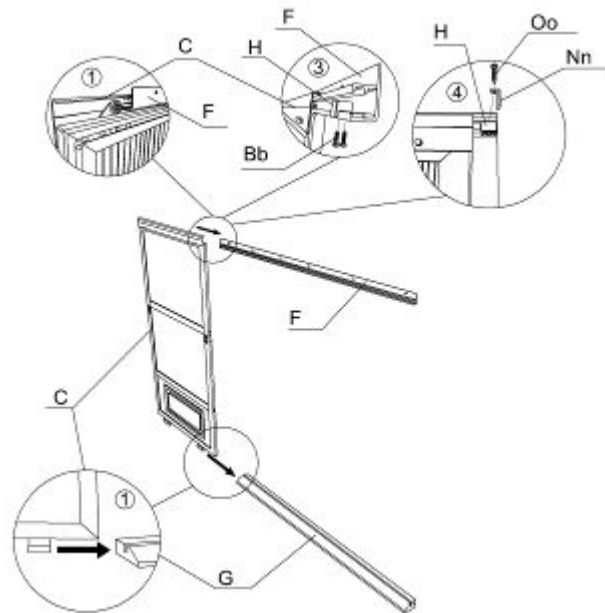

Step 3: Please note the sliding door should be installed from the inside of the solarium.

1. Place a bolt (Ww) and washer (Gg) through the top door rail (F) and door frame, and place a female bolt (Cc-2) from the other side. Once all are inserted, tighten them all securely.
2. Secure the bottom door rail (G), using a bolt (Cc) with a washer (Gg).
3. Paying careful attention to whether it is the left (Dd-L) or right (Dd-R) latch, use bolt (Bb) to affix the door latch onto the frame.

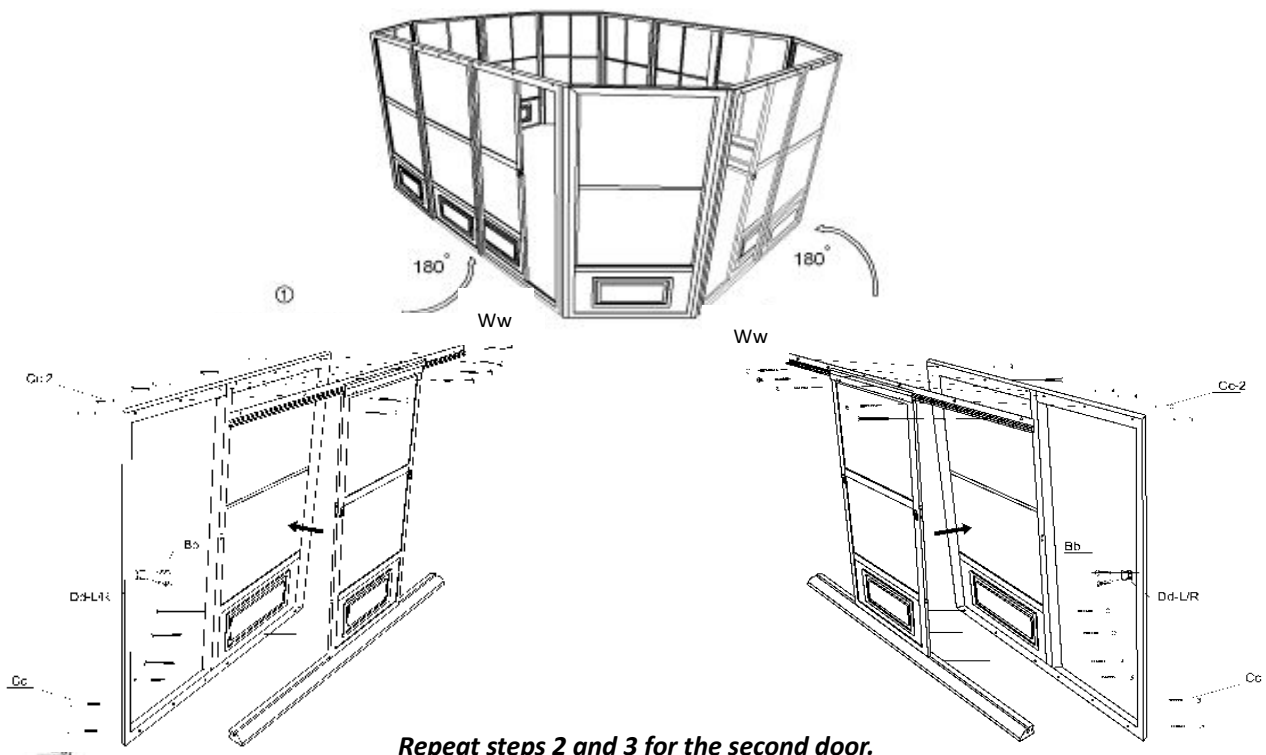

Repeat steps 2 and 3 for the second door.

Step 4:

1. Attach roof rafters (L) to the central hub (N) using bolt (Bb).
2. Use screw (Z) to affix the rafters (L) onto the top of panels going through the metal piece attached to the rafter (L).

Note: Rafters must be affixed where panels connect to each other.

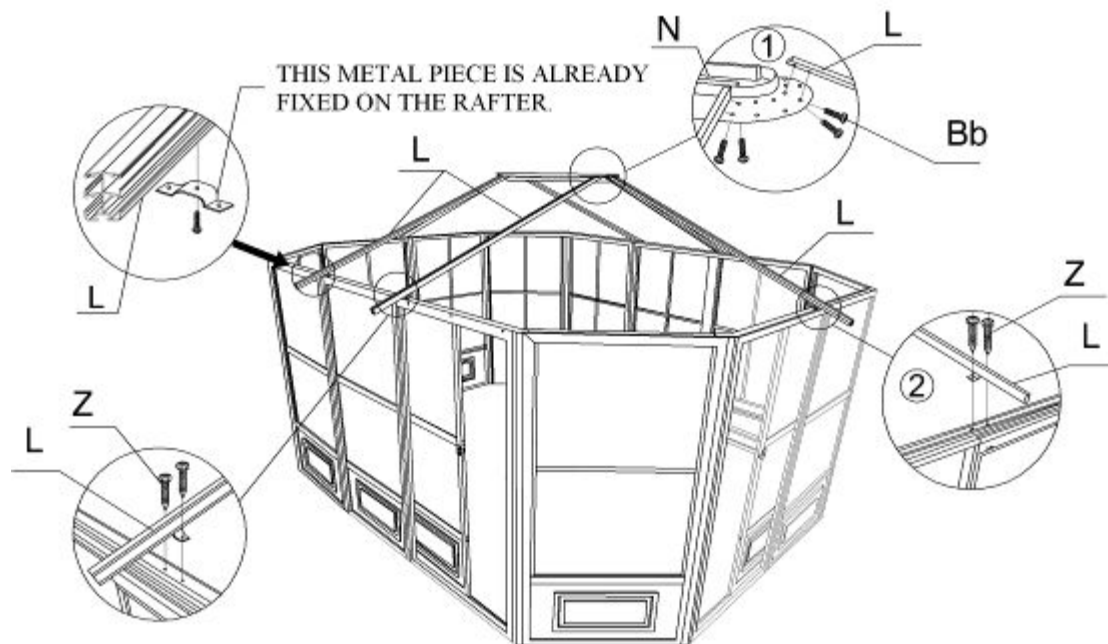

Step 5:

Use the same method to assemble roof rafters (K) for the angled panels. The rafters (K) should be affixed to the mounting bracket using the hole that will be furthest away from the corner of the unit.

Note: Do not tighten the bolts right away as you may have to adjust the angle when inserting the PC roof panels.

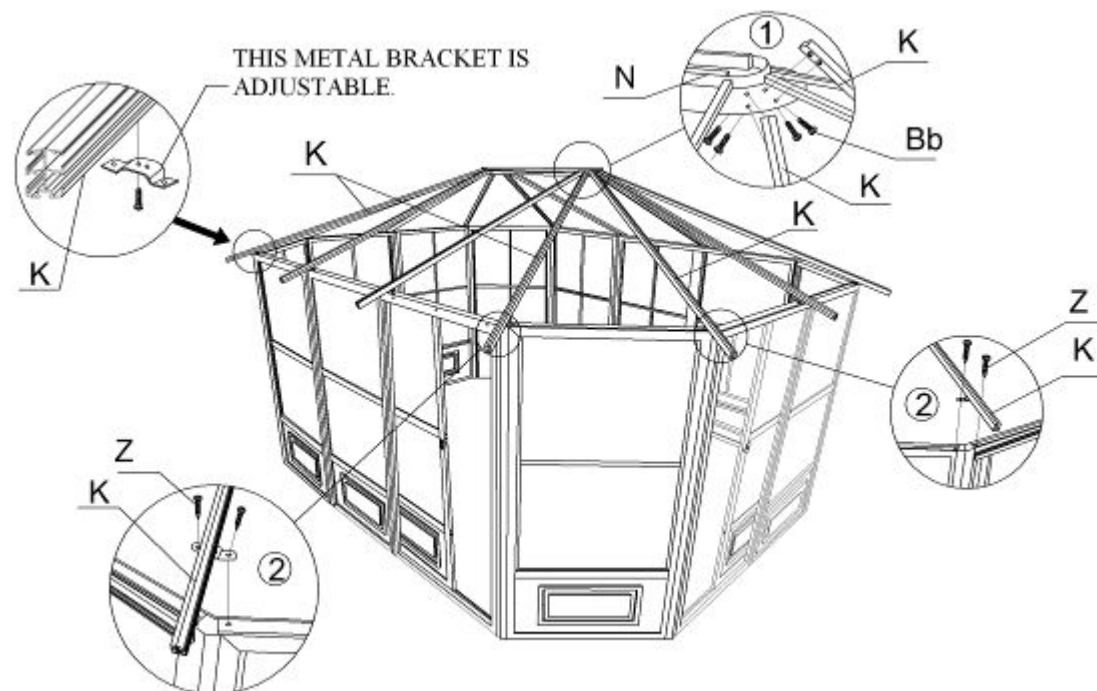

Step 6:

Use nut (Hh) and washer (Gg) to affix the top cap (M) to the central hub (N).

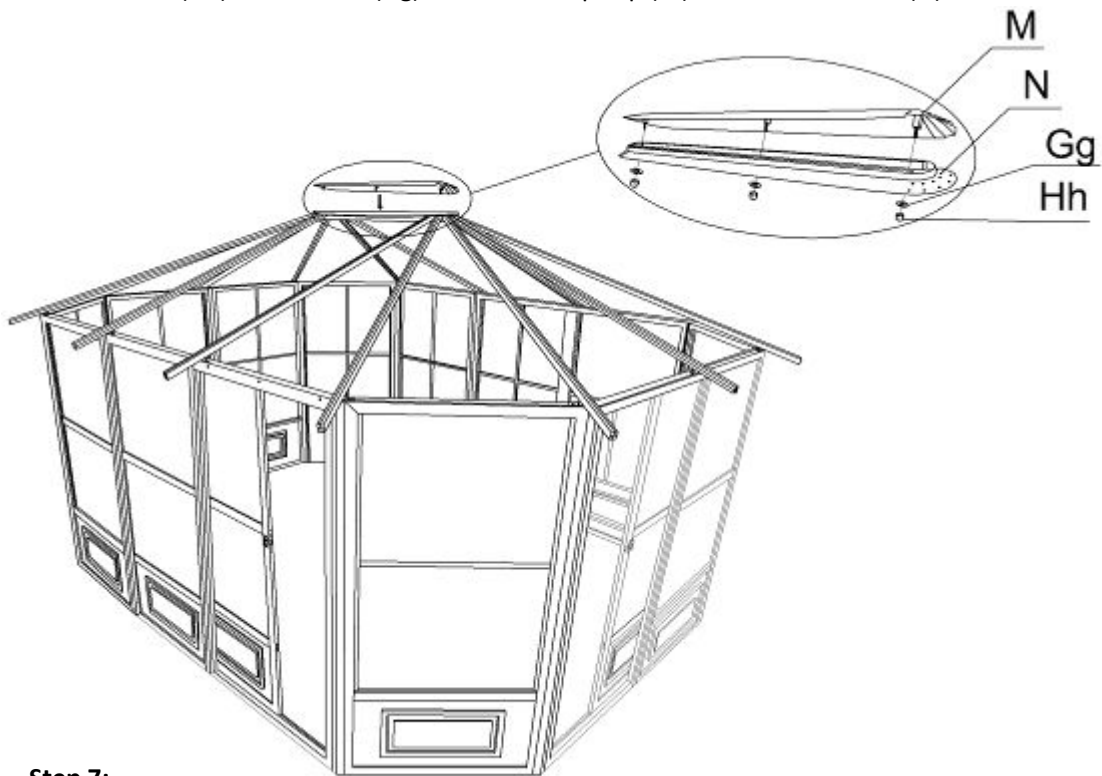

Step 7:

First remove the protective layer from the PC roof panels, then insert them (Y, Aa, Ll, Qq) into the roof rafters according to the below drawing instructions.

Note: the side that had the protective layer should be face down.

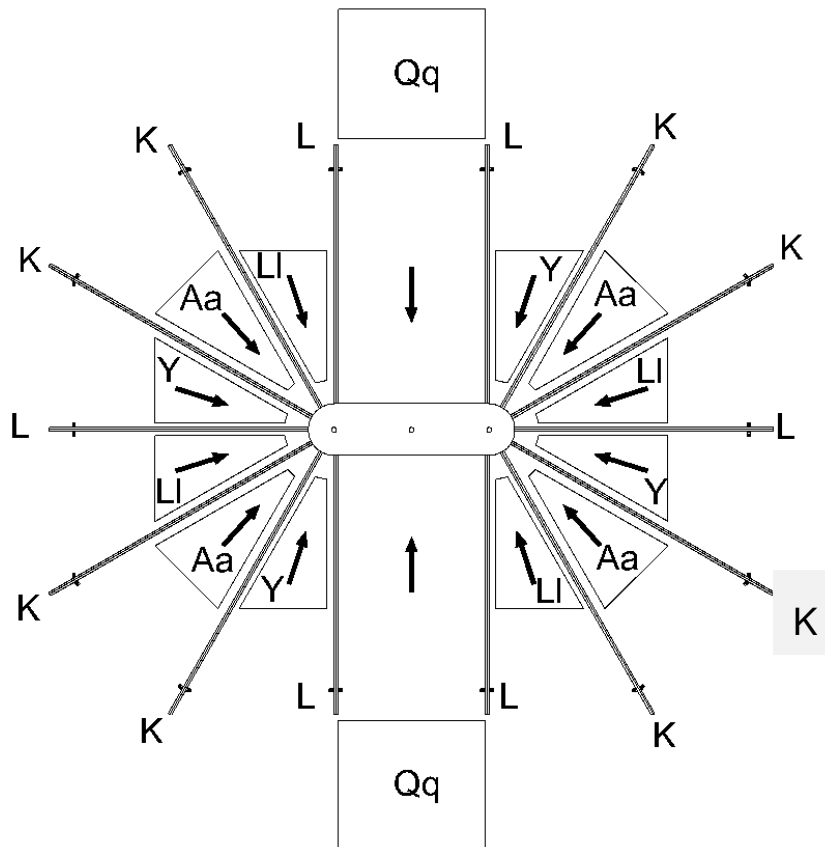

Step 8:

After inserting the upper PC panels, insert the aluminum middle roof joints (O, P, Q, Pp) into the roof rafters. The below drawing view is from inside the solarium looking up.

Note:

- The drain holes on the aluminum middle roof joints (O, P, Q, Pp) should be at the bottom.
 - To adjust the middle joints to line up : once all polycarbonate roof panels are in place, use a small piece of wood and hammer, then tap down on the middle of the joint bringing it down and holding at the same time the joint and top polycarbonate.
- Do not tap too hard.

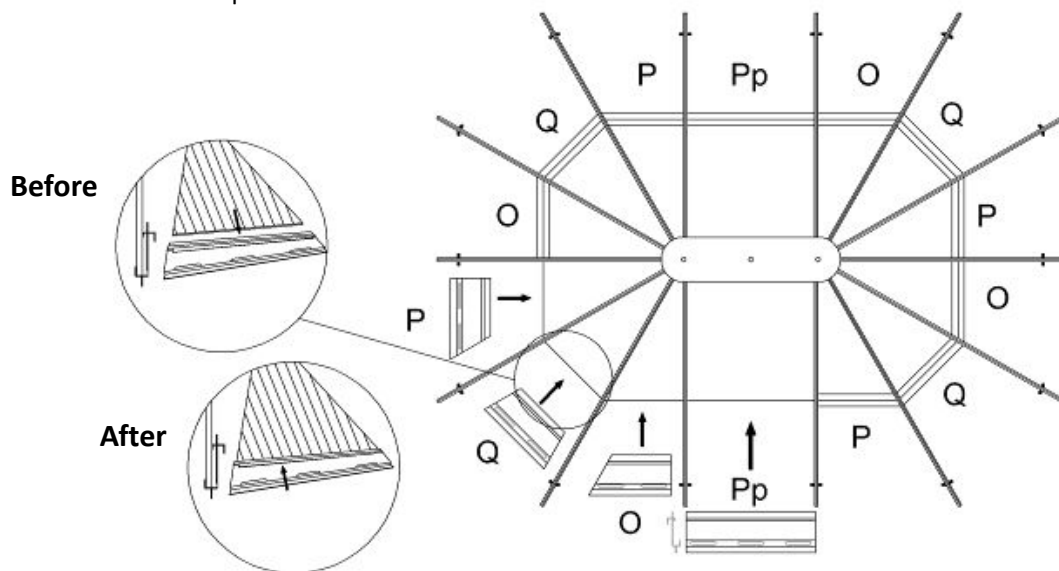

Step 9:

After the installation on the middle roof joints complete, insert the bottom PC roof panels (Jj, Kk, Mm, Rr) according to below drawing. They should overlap about two inches under the upper PC roof panels and into the aluminum middle roof joints.

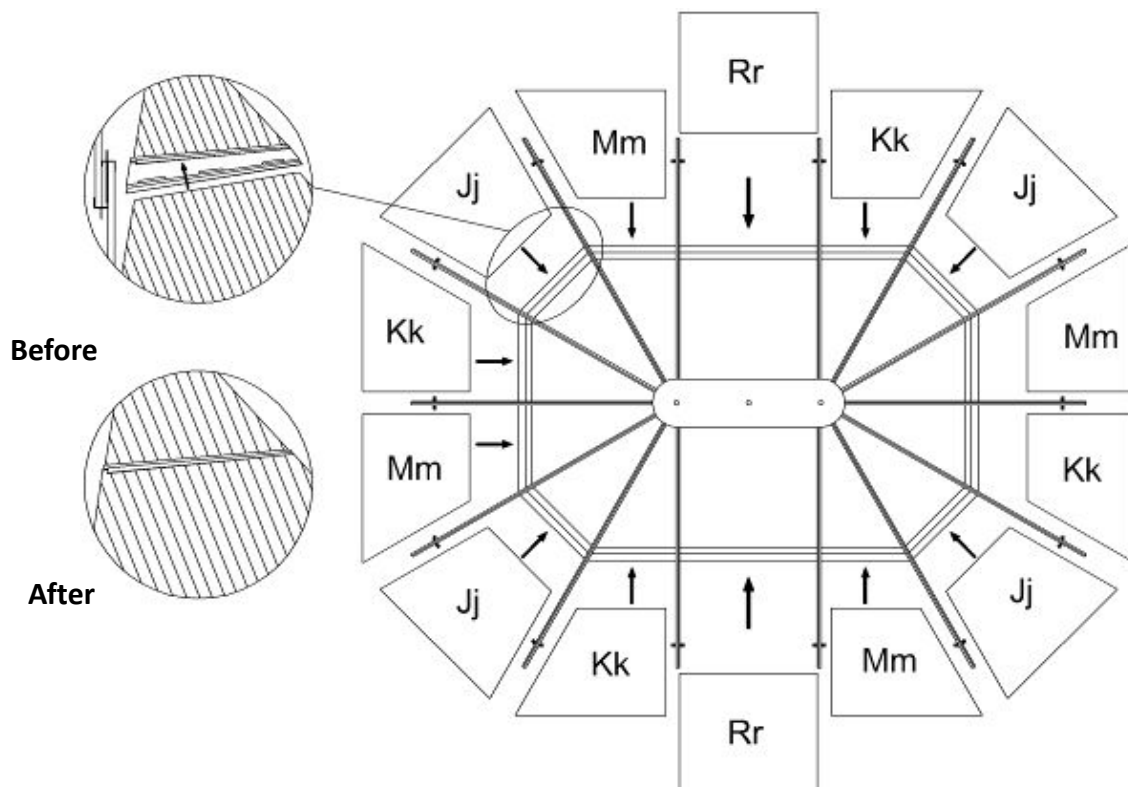

Step 10:

Once the PC roof is complete, use aluminum edging (S, U, W, Ss) to surround the edges of PC roof, and using bolt (Bb) and roof joint (R), tighten securely.

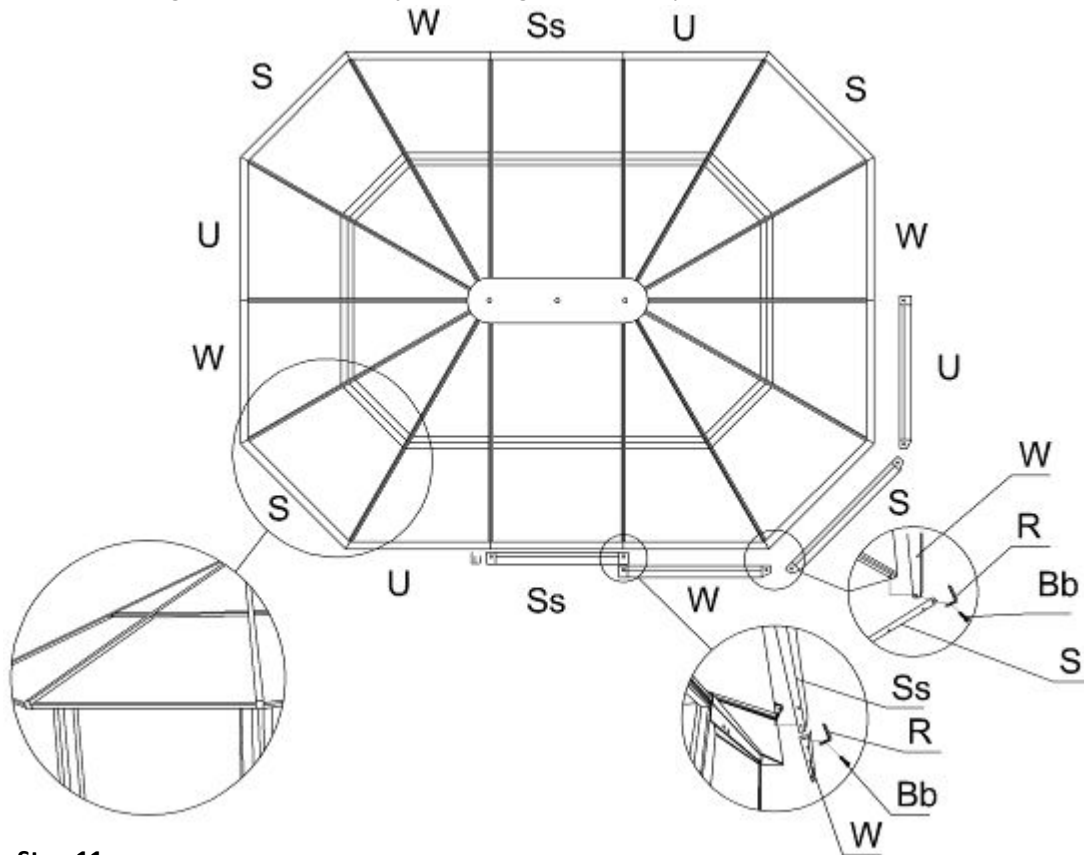

Step 11:

Once the installation of the edging complete, start affixing the roof cross bars (T, V, X, Tt) using bolt (Ff). Affix the top cross bars (Uu) onto the roof rafter (L) using bolt (Ff).

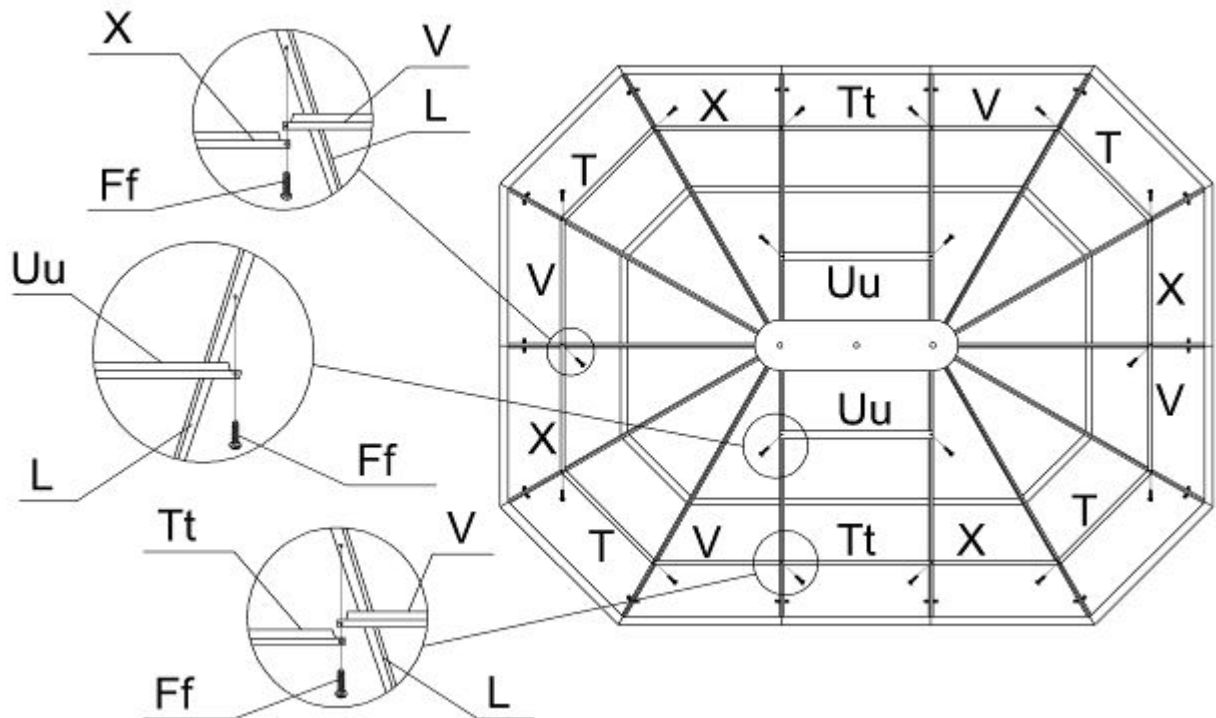

Step 12:

Inside each of the panels (A, B), push two plastic plugs (li) into the ground, and then screw down the panels using two screws (Ee) for each panels.

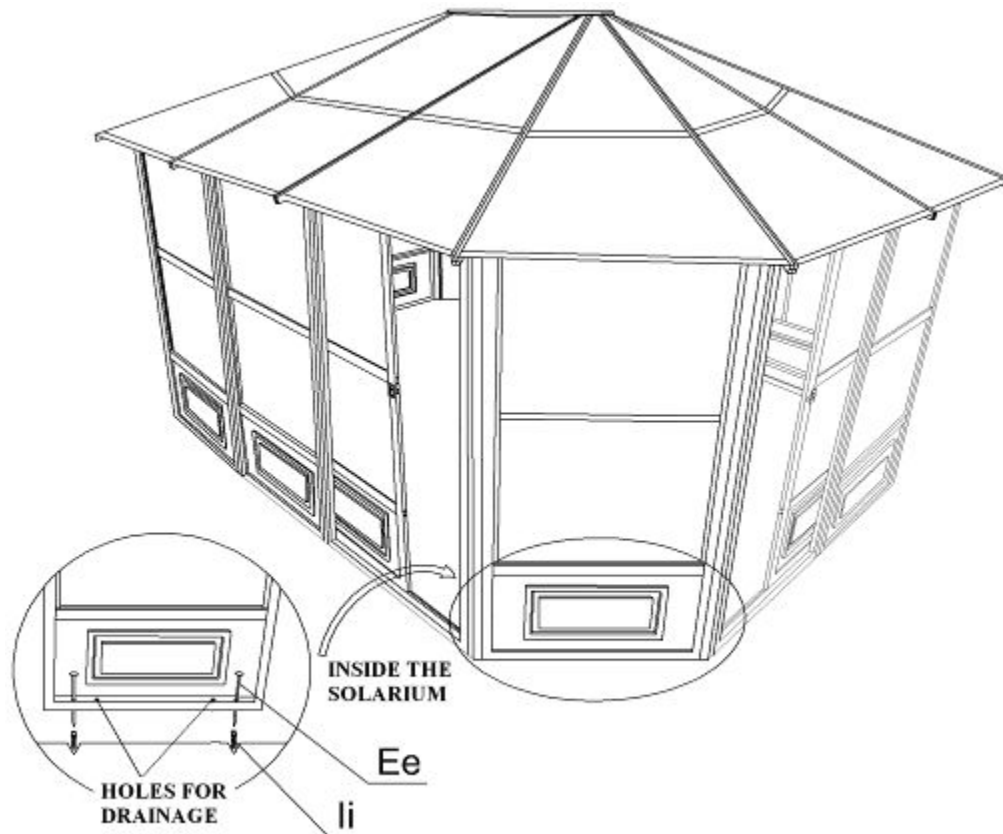





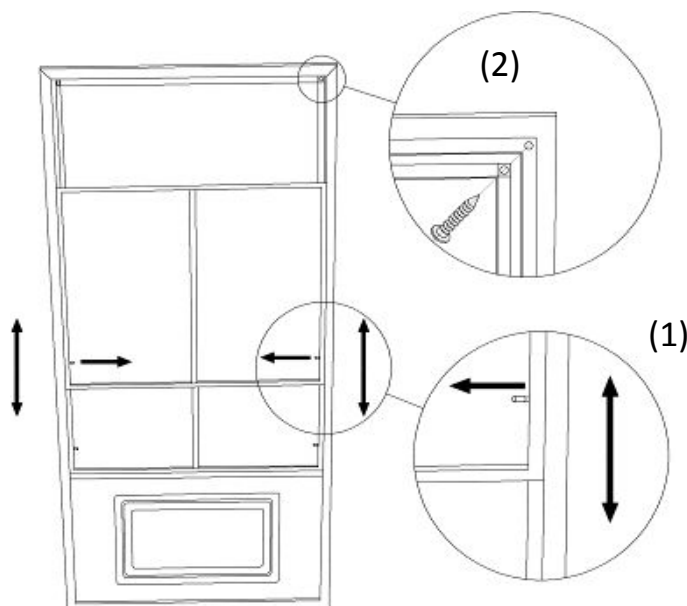



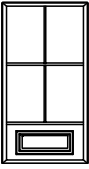
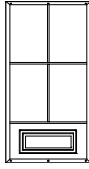
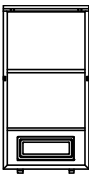
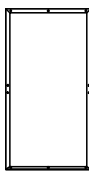

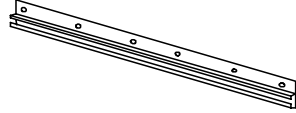
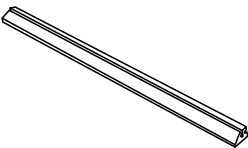

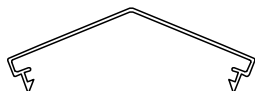
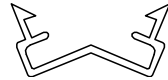

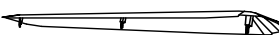
Special notes:

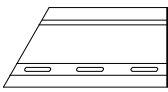
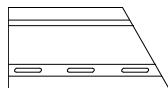
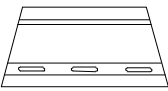
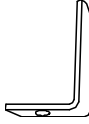

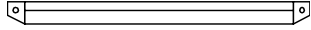
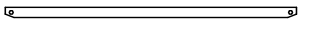
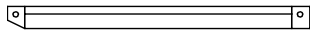

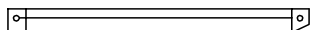
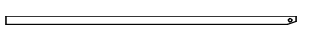
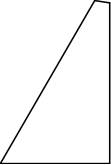
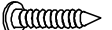
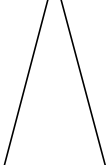
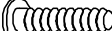
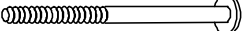
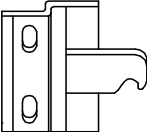
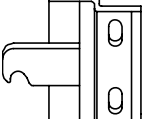
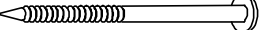
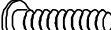



1. To remove windows (08-219), pull 1 pin out of the lock position and push the frame to the end of the track, then ease the window out of the tracks one side at a time.
2. To remove screening panel, first remove windows, then unscrew the 2 screws at the top corners of the screen frame.
3. Note that this unit is not waterproof. For best protection against rain, close the windows of each frame with the outside window in the center, and the inside window at the top.

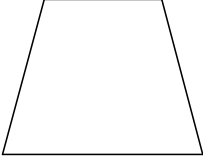
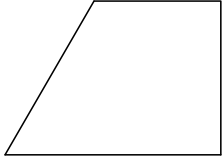
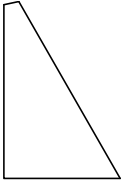
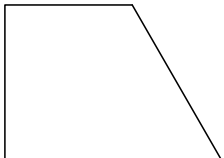

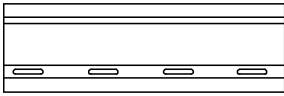



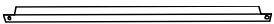

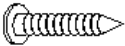

41215-12 SAND PARTS LIST

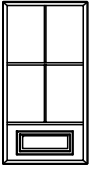
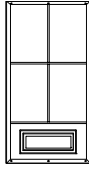
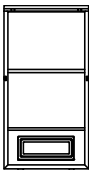
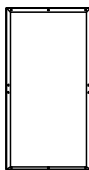

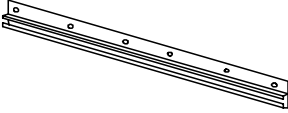
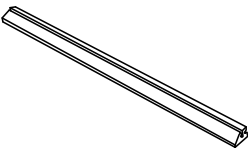
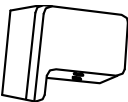
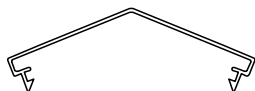
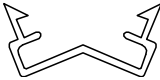

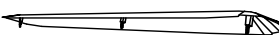

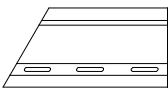
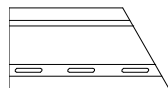
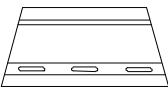

DESCRIPTION	PACKED IN BOX	QTY	DRAWING	DESCRIPTION	PACKED IN BOX	QTY	DRAWING
08-129-12 REGULAR FRAME A	3	6		08-130-12 FRAME NEXT TO DOOR B (with extra holes)	2	2	
	2	4					
08-131-12 SLIDING DOOR C	2	2		08-132-12 SLIDING DOOR FRAME D	2	2	
08-133-12 CONNECTING PIECE E	4	12		08-136-12 TOP DOOR RAIL F	4	2	
08-137-12 BOTTOM DOOR RAIL G	4	2		08-138-12 PLASTIC STOPPER H	5	4	
08-139-12 135° ANGLED OUTSIDE CONNECTOR I	4	8		08-140-12 135° ANGLED INSIDE CONNECTOR J	4	8	
08-141-12 ROOF RAFTER K	4	8		08-142-12 ROOF RAFTER L	4	6	
08-179-12 TOP CAP M	5	1		08-178-12 CENTRAL HUB N	5	1	
08-145-12 MIDDLE ROOF JOINT O	5	4		08-146-12 MIDDLE ROOF JOINT P	5	4	
08-147-12 MIDDLE ROOF JOINT Q	5	4		08-148-12 ROOF RAFTER CAP R	5	14	

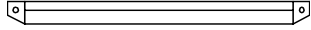
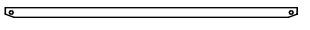
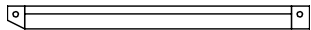
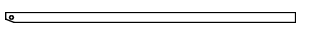

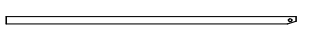

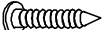
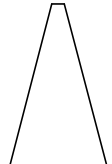
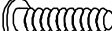
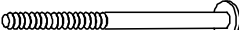
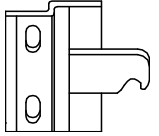
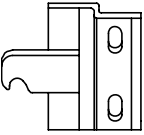
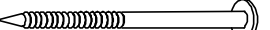
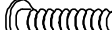

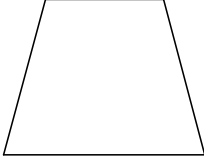
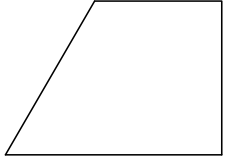
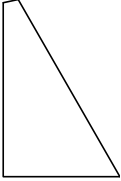
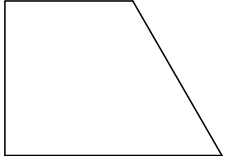
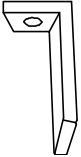

DESCRIPTION	PACKED IN BOX	QTY	DRAWING	DESCRIPTION	PACKED IN BOX	QTY	DRAWING
08-149-12 EDGING S	5	4		08-150-12 ROOF CROSS BAR T	5	4	
08-151-12 EDGING U	5	4		08-152-12 ROOF CROSS BAR V	5	4	
08-153-12 EDGING W	5	4		08-154-12 ROOF CROSS BAR X	5	4	
08-155-12 (24 1/4"X42 1/4") TOP ROOF LEFT PANEL Y	1	4		08-156-12 SCREW Z	5	28	 (M4*16mm)
08-157-12 (24 1/2"x46 1/2") TOP ROOF CORNER PANEL Aa	1	4		08-158-12 BOLT Bb	5	54	 (M6*16mm)
08-161-12 BOLT Cc	5	12	 (M6*70mm)	08-165-12 RIGHT DOOR LATCH Dd-R	5	2	
08-169-12 LEFT DOOR LATCH Dd-L	5	2		08-167-12 SCREW Ee	5	24	 (M6*100mm)
08-168-12 BOLT Ff	5	18	 (M6*12mm)	08-187-12 WASHER Gg	5	39	
08-189-12 ACORN NUT Hh	5	3		08-193-12 PLASTIC PLUG Ii	5	24	

DESCRIPTION	PACKED IN BOX	QTY	DRAWING	DESCRIPTION	PACKED IN BOX	QTY	DRAWING
08-195-12 (47"x47 1/2") BOTTOM ROOF CORNER PANEL Jj	1	4		08-196-12 (46 1/4"x43") BOTTOM ROOF LEFT PANEL Kk	1	4	
08-197-12 (24 1/4"x42 1/2") TOP RIGHT ROOF PANEL Ll	1	4		08-198-12 (46 1/4"x43") BOTTOM ROOF RIGHT PANEL Mm	1	4	
08-134-12 UPPER DOOR RAIL END CAP Nn	5	4		08-135-12 SCREW Oo	5	4	 (M4*12mm)
08-170-12 MIDDLE ROOF JOINT Pp	5	2		08-172-12 (41 1/4"x42 1/4") TOP ROOF CENTER PANEL Qq	1	2	
08-171-12 (41 1/4"x43") BOTTOM ROOF CENTER PANEL Rr	1	2		08-173-12 EDGING Ss	5	2	
08-174-12 ROOF CROSS BAR Tt	5	2		08-175-12 TOP ROOF CROSS BAR Uu	5	2	
12-037-12 FEMALE BOLT Cc-2	5	12	 M6*60mm	12-047-12 BOLT Ww	5	12	 M5*15mm
08-219-12			PVC Window for solarium (on the frames)				

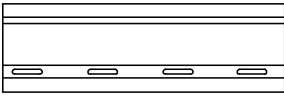
41215-32 SLATE PARTS LIST

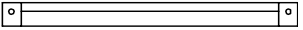
DESCRIPTION	PACKED IN BOX	QTY	DRAWING	DESCRIPTION	PACKED IN BOX	QTY	DRAWING
08-129-32 REGULAR FRAME A	3	6		08-130-32 FRAME NEXT TO DOOR B (with extra holes)	2	2	
	2	4					
08-131-32 SLIDING DOOR C	2	2		08-132-32 SLIDING DOOR FRAME D	2	2	
08-133-32 CONNECTING PIECE E	4	12		08-136-32 TOP DOOR RAIL F	4	2	
08-137-32 BOTTOM DOOR RAIL G	4	2		08-138-32 PLASTIC STOPPER H	5	4	
08-139-32 135° ANGLED OUTSIDE CONNECTOR I	4	8		08-140-32 135° ANGLED INSIDE CONNECTOR J	4	8	
08-141-32 ROOF RAFTER K	4	8		08-142-32 ROOF RAFTER L	4	6	
08-179-32 TOP CAP M	5	1		08-178-32 CENTRAL HUB N	5	1	
08-145-32 MIDDLE ROOF JOINT O	5	4		08-146-32 MIDDLE ROOF JOINT P	5	4	
08-147-32 MIDDLE ROOF JOINT Q	5	4		08-148-32 ROOF RAFTER CAP R	5	14	

DESCRIPTION	PACKED IN BOX	QTY	DRAWING	DESCRIPTION	PACKED IN BOX	QTY	DRAWING
08-149-32 EDGING S	5	4		08-150-32 ROOF CROSS BAR T	5	4	
08-151-32 EDGING U	5	4		08-152-32 ROOF CROSS BAR V	5	4	
08-153-32 EDGING W	5	4		08-154-32 ROOF CROSS BAR X	5	4	
08-155-32 (24 1/4"X42 1/4") TOP ROOF LEFT PANEL Y	1	4		08-156-32 SCREW Z	5	28	 (M4*16mm)
08-157-32 (24 1/2"x46 1/2") TOP ROOF CORNER PANEL Aa	1	4		08-158-32 BOLT Bb	5	54	 (M6*16mm)
08-161-32 BOLT Cc	5	12	 (M6*70mm)	08-165-32 RIGHT DOOR LATCH Dd-R	5	2	
08-169-32 LEFT DOOR LATCH Dd-L	5	2		08-167-32 SCREW Ee	5	24	 (M6*100mm)
08-168-32 BOLT Ff	5	18	 (M6*12mm)	08-187-32 WASHER Gg	5	39	
08-189-32 ACORN NUT Hh	5	3		08-193-32 PLASTIC PLUG Ii	5	24	

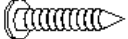
DESCRIPTION	PACKED IN BOX	QTY	DRAWING	DESCRIPTION	PACKED IN BOX	QTY	DRAWING
08-195-32 (47"x47 1/2") BOTTOM ROOF CORNER PANEL Jj	1	4		08-196-32 (46 1/4"x43") BOTTOM ROOF LEFT PANEL Kk	1	4	
08-197-32 (24 1/4"x42 1/2") TOP RIGHT ROOF PANEL Ll	1	4		08-198-32 (46 1/4"x43") BOTTOM ROOF RIGHT PANEL Mm	1	4	
08-134-32 UPPER DOOR RAIL END CAP Nn	5	4		08-135-32 SCREW Oo	5	4	 (M4*12mm)
08-170-32 MIDDLE ROOF JOINT Pp	5	2		08-172-32 (41 1/4"x42 1/4") TOP ROOF CENTER PANEL Qq	1	2	
08-171-32 (41 1/4"x43") BOTTOM ROOF CENTER PANEL Rr	1	2		08-173-32 EDGING Ss	5	2	
08-174-32 ROOF CROSS BAR Tt	5	2		08-175-32 TOP ROOF CROSS BAR Uu	5	2	
12-037-32 FEMALE BOLT Cc-2	5	12	 M6*60mm	12-047-32 BOLT Ww	5	12	 M5*15mm
08-219-32			PVC Window for solarium (on the frames)				

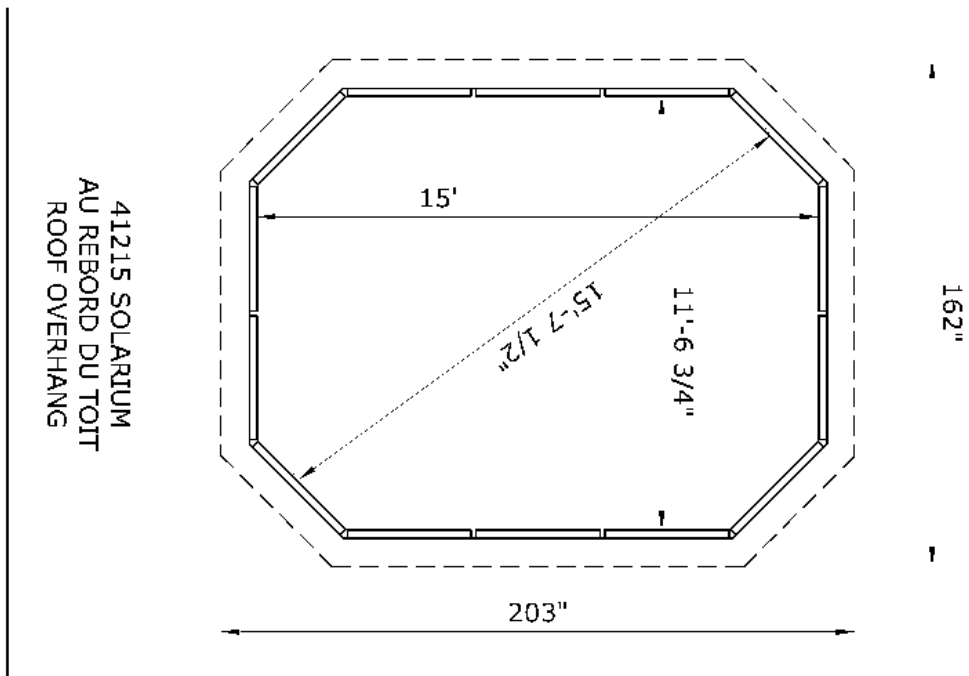
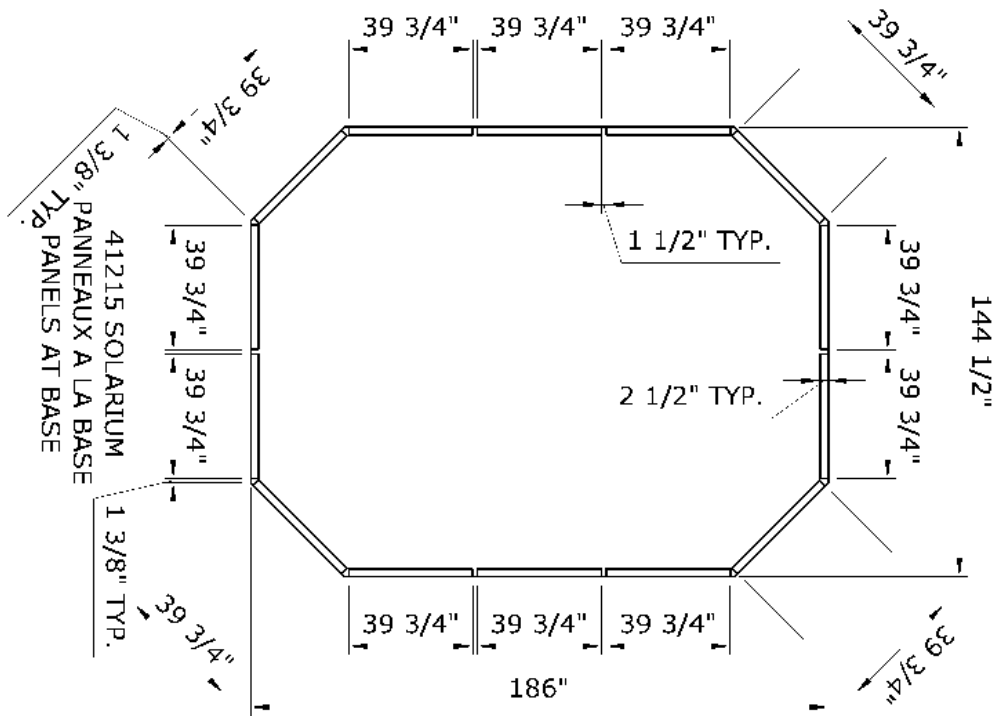

MAINTENANCE NOTES

1. In case of a defective or damaged part, or for any other questions concerning the product, please contact the manufacturer directly.
2. Please have the parts list and part numbers on hand when ordering or requesting replacement parts.
3. The product should not be installed adjacent to trees or a sloped roof. Snow and ice may slide onto the roof and cause it to collapse.
4. While the product is designed for 4 seasons use, the roof must be kept free of accumulation of snow.



ONE YEAR LIMITED WARRANTY

This product has been designed and manufactured to meet the highest standards of quality and durability. Subject to the Conditions for Exercising the Warranty and the Limitations on the Warranty set forth below, it is warranted to be free of material and manufacturing defects for a period of **one year** from the date of purchase. Should the product become damaged, or the warranty period has expired, please contact Gazebo Penguin Customer Service Department for a complete schedule of replacement parts and prices.

CONDITIONS FOR EXERCISING THE WARRANTY

The warranty only applies to the original purchaser with the bill.

In order to properly exercise your warranty, please comply with the following:

Carefully inspect the contents of the carton for missing or damaged components.

Should you discover damaged or missing parts, **do not return the product to the place of purchase**, but contact Gazebo Penguin Customer Service Department at the numbers listed below:

Montreal: (514) 276-3485

Elsewhere: 1-800-737-7174

You can also find a claim form to fill out online :

<http://www.abrispenguin.com/forms.html>

LIMITATIONS ON THE WARRANTY

1. The product is not warranted against damages due to vandalism, abuse, falling or thrown objects, or accumulation of snow.
2. The product is not warranted against damages due to extreme weather conditions, such as thunderstorms, hail, strong wind or snow storms, or any other acts of God.
3. The product is only warranted in the event it is installed in accordance with the Gazebo Penguin's written instructions enclosed with the product.
4. The product is not warranted in the event it has been improperly anchored.
5. We reserve the right to replace or repair any defective product or parts at our discretion.